





<b>Number</b> BAW 17-073/01/A <b>Replaces:</b> -	   <b>BDA Agrément® BAW 17-073/01/A</b>	<b>Category</b> Thermal insulation system for external walls
<b>Date</b> 2017-08-02		<b>Phase</b> Assessment
<b>Project number</b> 17-E-0557 / 2376		<b>Subject</b> Blown-in cavity wall insulation system
<b>Validity</b> www.kiwa.co.uk/bda		
<b>System</b>		
<b>Agrément holder</b>	<b>Provincial Seals superbead</b> Provincial Seals Ltd. Unit 3 Kingsway House GATESHEAD NE11 OHW, UK T : +44 (0) 1661 842221 E : info@provincialseals.co.uk W : http://www.provincialseals.co.uk/	
<b>Description</b>	EPS bead material to be used as a blown-in thermal insulation within the cavity of masonry cavity walls. An air drying adhesive can be used as a bonding agent, simultaneously blown-in with the EPS beads to provide long term stability to the insulant. The nominal density for the product after installation is 12 kg · m <sup>-3</sup> and local areas within the wall when sampled over an area of 0.5 m <sup>2</sup> may have nominal density variations of ± 2.0 kg · m <sup>-3</sup> .	
<b>Scope (use)</b>	A System for Cavity Wall Insulation (hereafter CWI) for use in new (see section 7.3) and existing (see section 7.2, in cavities at least 40 mm wide) residential and non-residential buildings. The product may be used in buildings over 12 m in height where a height restriction waiver has been issued by the Agrément holder.	
<b>Objective</b>	This document provides independent information to specifiers, building control personnel, contractors, installers and other construction industry professionals considering the fitness for the intended use of the System.	
<b>Summary of Agrément</b>	This Agrément covers the following: <ul style="list-style-type: none"> <li>• Conditions of use;</li> <li>• Sources, including codes of practice, test and calculation reports;</li> <li>• Independently assessed system characteristics and other system information;</li> <li>• Factory Production Control and annual verification procedure;</li> <li>• Points of attention for the specifier and typical drill patterns;</li> <li>• Installation procedure;</li> <li>• Compliance with Building Regulations and non-Regulatory Standards.</li> </ul>	
<b>Major points of assessment</b>	<p><b>Adequacy of fill (section 3)</b> Partially filled cavity walls, party walls with a cavity and difficult to fill areas of a cavity wall (e.g. the area located over a conservatory) can be filled sufficiently with the System.</p> <p><b>Resistance to moisture (section 3)</b> The System does not absorb water by capillary action and may therefore be used in situations where the EPS insulation bridges the damp proof course (DPC) of the inner and outer leaf of masonry cavity walls in new and existing domestic and non-domestic buildings.</p> <p><b>Thermal performance aspects (section 7.5)</b> The System can enable external walls (masonry cavity walls) to meet the design U-values specified in the documents supporting the national Building Regulations.</p> <p><b>Condensation risk (section 7.6)</b> The System can contribute to minimising the risk of interstitial and surface condensation in external walls.</p> <p><b>Durability (section 7.9)</b> The EPS insulation product is stable, rot-proof and durable and will remain so for the life of the building in which it is installed.</p>	
<b>Statement</b>	The opinion of the Kiwa BDA Expert Centre Building Envelope (ECBE) is that the System Provincial Seals superbead is fit for the intended use, provided it is specified, installed and used in accordance with this Agrément.  <div style="display: flex; justify-content: space-between;"> <div style="width: 45%;"> <p>Professor Nico Hendriks, MSc</p>  <p>ECBE Chairman</p> </div> <div style="width: 45%;"> <p>Chris van der Meijden, MSc</p>  <p>BDA Group Technical Director</p> </div> </div>	
<b>Version</b> 01	<b>Kiwa BDA Expert Centre Building Envelope (ECBE)</b> <b>BDA Group</b> Avelingen West 33 P.O. Box 389 4200 AJ Gorinchem The Netherlands +31 (0)183 66 96 90  Copyright© 2017 Kiwa BDA www.kiwa.co.uk/bda	Page 1 of 9 pages

<p><b>1 Conditions of use</b></p>	<p><b>1 Application</b> The assessment of the System relates to the use of the System in new and existing residential and non-residential buildings with correctly installed masonry external walls, which have been designed and constructed in accordance with this Agrément and with the Agrément holder's requirements. Masonry is understood to mean clay and calcium silicate bricks, concrete blocks, natural stone and similar stone-like materials.</p> <p><b>2 Assessment</b> Kiwa BDA Expert Centre Building Envelope (ECBE) has assessed the thermal performance, design and installation of the System according to BS EN ISO 6946<sup>3</sup>, BR443<sup>4</sup>, BS 5250<sup>6</sup>, BS 8102<sup>7</sup>, BS 8215<sup>8</sup>, BS EN 1996-1-1<sup>9</sup>, UK NA to BS EN 1996-1-1<sup>10</sup> in combination with the provided information and Technical Assessment and site visits. Also NHBC Standards<sup>2</sup> have been taken into account. Factory Production Control has been assessed by Kiwa N.V., Technical Assessment Body, represented in the UK by Kiwa Ltd.<sup>17</sup>.</p> <p><b>3 Installation</b> It is recommended that the quality of installation and workmanship is controlled by a competent person. Such a person shall be either a qualified employee of the Agrément holder or an employee of the installing contractor, qualified by the Agrément holder. The product shall be installed strictly in accordance with the requirements of the Agrément holder and the requirements of this Agrément.</p> <p><b>4 Geographical scope</b> The validity of this document is limited to England, Wales, Scotland, Northern Ireland and Ireland, with due regard to section 10 Building Regulations.</p> <p><b>5 Validity</b> The purpose of this BDA Agrément<sup>®</sup> is to provide for well-founded confidence to apply Provincial Seals superbead in the described applications and according to approved specifications. According to the BDA Guideline<sup>1</sup> the validity of this Agrément is therefore three years after the official date of issue, published on <a href="http://www.kiwa.co.uk/bda">www.kiwa.co.uk/bda</a>. After this the validity can be extended every three years after positive review. This Agrément is not valid in those cases where ECBE identifies that the design of the System does not comply with article 7.1.</p>	
<p><b>2 Sources</b></p>	<ol style="list-style-type: none"> <li>1 BDA Guideline - BDA Agrément<sup>®</sup>, 30 June 2015</li> <li>2 NHBC Standards 2017, Chapter 2.1 The Standards and Technical Requirements, Chapter 6.1 External masonry walls</li> <li>3 BS EN ISO 6946:2007 Building components and building elements. Thermal resistance and thermal transmittance. Calculation method</li> <li>4 BR443: Conventions for U-value calculations, 2006 edition, BRE Scotland</li> <li>5 BR262: Thermal insulation: avoiding risks, 2002 edition, BRE Scotland</li> <li>6 BS 5250:2011 Code of practice for control of condensation in buildings</li> <li>7 BS 8102:1990 Code of practice for protection of buildings against water from the ground</li> <li>8 BS 8215:1991 Code of practice for design and installation of damp proof courses in masonry construction</li> <li>9 BS EN 1996-1-1:2005+A1:2012 Eurocode 6. Design of masonry structures. General rules for reinforced and unreinforced masonry structures</li> <li>10 UK NA to BS EN 1996-1-1:2005+A1:2012</li> <li>11 BS EN 16809-1 (<i>Draft for public comment</i>). Thermal insulation products for buildings. In-situ formed products from loose-fill expanded polystyrene (EPS) beads and bonded expanded polystyrene beads. Part 1. Specification for the bonded and loose filled products before installation</li> <li>12 BS EN 1609:2013 Thermal insulating products for building applications. Determination of short term water absorption by partial immersion</li> <li>13 CIGA Technician's guide to best practice - Flues, chimneys and combustion air ventilators, Version 3.0, issued May 2006</li> <li>14 Provincial Seals, Thermal reconciliation sheet, version 1, July 2017</li> <li>15 Provincial Seals, System Manual, August 2016 - revised July 2017</li> <li>16 CIGA, High Rise Building Assessment, assessment form: version 4, April 2013</li> <li>17 Kiwa Ltd. Report Of Inspection Of Factory And Factory Production Control, issued 2017-04-18</li> <li>18 Kiwa BDA Report, the adequacy of fill of injected cavity wall insulation, issued 2017-04-20</li> <li>19 Kiwa BDA Testing, Test Report no. 0106-C-17/1: determination of ignitability, issued 2017-04-18</li> <li>20 Kiwa BDA Testing, Test Report no. 0106-C-17/2: classification of reaction to fire, issued 2017-04-18</li> </ol>	
<p><b>Version</b> 01</p>	<p style="text-align: center;"><b>Expert Centre Building Envelope</b> Copyright<sup>©</sup> 2017 Kiwa BDA</p>	<p>Page 2 of 9 pages</p>

<p><b>2 Sources</b> (continued)</p>	<p>21 Kiwa BDA Testing, Test Report no. 0106-C-17/3: determination of product characteristics, issued 2017-04-18 22 Technical Guidance Document B - Fire Safety, Building Regulations 2006, Department of the environment, Heritage and local government, Ireland</p> <p><b>Remark:</b> in the text of this document reference is made to some of these sources by adding the relevant reference number in superscript.</p>
<p><b>3 Independently assessed system characteristics of components used for critical functions **)</b></p>	<p>**) The critical functions which apply to this section and section 4 are weatherproofing, durability and thermal insulation, as mentioned in Chapter 2.1, Technical Requirement R3 (Materials requirement) of the NHBC Standards<sup>2</sup>.</p> <p><b>Provincial Seals superbead, as installed</b></p> <ul style="list-style-type: none"> <li>• <b>Declared thermal conductivity <math>\lambda_{90/90}</math> (<math>W \cdot m^{-1} \cdot K^{-1}</math>)</b><sup>11,14</sup> : 0.033</li> <li>• <b>Water absorption</b><sup>12,21</sup> : 0.30 <math>kg \cdot m^{-2}</math></li> </ul> <p>This low figure means there is no capillary action: the insulation does not allow water to bridge the cavity from the outer leaf to the inner leaf via the insulation. Water penetrating the outer leaf will drain down the cavity face of the outer leaf.</p> <ul style="list-style-type: none"> <li>• <b>Adequacy of fill</b> The fill of cavity walls with the System has been examined during project visits<sup>18</sup>. Important aspects which are assessed are: <ul style="list-style-type: none"> <li>- Use of the thermal lance to fill the cavity of a gable wall and the cavity between two (2) windows. This gives confidence party walls can be filled adequately.</li> <li>- The full fill of cavities.</li> <li>- The filling with the drilling pattern and the recommended distances between the drilling holes.</li> </ul> </li> <li>• <b>Reaction to fire classification</b><sup>20</sup> <ul style="list-style-type: none"> <li>- Provincial Seals superbead : class F</li> </ul> </li> </ul>
<p><b>4 Factory Production Control (FPC)</b></p>	<p>Kiwa N.V., Technical Assessment Body, represented by Kiwa Ltd. has determined that the System fulfills all provisions concerning the specifications described in this Agrément. The FPC audits<sup>17</sup> were conducted in March 2017. Based on information provided during the audit / site inspection and actions afterwards a positive recommendation is given for FPC certification and a BDA Agrément<sup>®</sup> for the System.</p>
<p><b>5 Quality Management System</b></p>	<p>An effective and well maintained Quality Management System (QMS) is in place.</p>
<p><b>6 Continuous surveillance</b></p>	<p>In order to demonstrate that the FPC is in conformity with the requirements of the technical specification described in this Agrément the continuous surveillance, assessment and approval of the FPC will be done in a frequency of not less than once per year by Kiwa Ltd.</p>
<p><b>7 Points of attention for the specifier</b></p>	<p><b>1 Permitted applications</b> - only applications designed according to the specifications as given in this Agrément are allowed under this Agrément; in each case the specifier will have to cooperate closely with the Agrément holder.</p> <p><b>2 Existing buildings</b> - existing buildings shall be assessed in accordance with section 1.3 of this Agrément; in addition the requirements of the System Manual<sup>15</sup> apply; special attention shall be given to the condition of the external leaf with regard to repairs and the type of pointing; - mandatory is use of a borescope and a tape measure or ruler at a number of locations on each wall to be filled to assess the width of the cavity and to ensure a clear void exists; the findings of this survey shall be recorded on the assessment survey sheet; - The System shall be specified to comply with the requirements about resistance to moisture as given in either the relevant national Building Regulations or a BRE publication<sup>5</sup>.</p>
<p><b>Version</b> 01</p>	<p style="text-align: center;"><b>Expert Centre Building Envelope</b> Copyright © 2017 Kiwa BDA</p>
<p style="text-align: right;">Page 3 of 9 pages</p>	

<p><b>7 Points of attention for the specifier</b> (continued)</p>	<p><b>3 New buildings</b></p> <ul style="list-style-type: none"> <li>- for new buildings an inspection shall be performed as described in section 7.2;</li> <li>- external masonry walls, including cavity widths, shall be constructed in accordance with Chapter 6.1 (External Masonry Walls) of the NHBC Standards<sup>2</sup>; with particular attention to sections 6.1.6 (Exposure) and 6.1.7 (Thermal insulation) of the NHBC Standards;</li> <li>- suitable wall constructions for use with full-fill cavity insulation are given in table 2 in Chapter 6.1 (External Masonry Walls)<sup>2</sup>; fully filled cavities of walls with fair-faced masonry are not permitted in a very severe exposure zone.</li> </ul> <p><b>4 Building physics - general</b></p> <ul style="list-style-type: none"> <li>- the building physical behaviour of walls incorporating CWI shall be verified as suitable by a specialist; the specialist can be either a qualified employee of the specifier or a qualified consultant; the qualified person will check the building physical behaviour of the designed external wall construction and if need be, advise about improvement to achieve the final specification; it is recommended that he would cooperate closely with the Agrément holder.</li> </ul> <p><b>5 Thermal performance aspects</b></p> <ul style="list-style-type: none"> <li>- for the purpose of U-value calculations and to determine if the requirements of the Building (or other statutory) Regulations are met, the thermal resistances of the constructions shall be calculated according to BS EN ISO 6946<sup>3</sup>, BR443<sup>4</sup>, and BS 5250<sup>6</sup> as appropriate;</li> <li>- the Agrément holder can provide a service to provide for U-value calculations and other building physical aspects;</li> <li>- the requirement for limiting the heat loss through the building fabric, including the effect of thermal bridging can be satisfied if the U-values of the building elements do not exceed the maximum values in the relevant Elemental Methods given in the national Building Regulations of England (Approved Document L), Wales (Approved Document L), Scotland (Technical Standards Regulations 9), Northern Ireland (Technical Booklet F) and Ireland (Approved Document L); further information on Building Regulations is given in section 10 of this Agrément.</li> </ul> <p><b>6 Condensation risk</b></p> <ul style="list-style-type: none"> <li>- external walls incorporating the System will adequately limit the risk of interstitial condensation when designed in accordance with BS 5250<sup>6</sup>; a condensation risk analysis shall be completed at design stage.</li> </ul> <p><b>7 Combustion air ventilation requirements</b></p> <ul style="list-style-type: none"> <li>- if a combustion air ventilator is required, one must be fitted before the installer can proceed with the CWI; if necessary seek guidance in CIGA Technician's guide<sup>13</sup> to best practice;</li> <li>- The CWI shall not be installed unless the installer can gain entry to the property, and is able to complete the necessary pre-site inventory and all on-site checks (internal and external). If due to the installation of CWI the combustion air ventilators or flues of fuel-burning appliances would be blocked, there is a risk of someone becoming ill or dying of carbon monoxide poisoning;</li> <li>- to attain a level of competence, technicians must have successfully completed a training course covering all checks and inspections referred to in this guide; training centres shall be equipped to carry out practical smoke and spillage testing.</li> </ul> <p><b>Legal requirements</b></p> <ul style="list-style-type: none"> <li>- the main legal requirements for protection of the public and employees are the general provisions of the Health and Safety at Work Act 1974, and related legislation, including the Management of Health and Safety at Work Regulations 1999.</li> </ul> <p><b>8 Maintenance and consulting service</b></p> <ul style="list-style-type: none"> <li>- once installed strictly in accordance with the requirements of this Agrément and of the Agrément holder, the System components are within the wall structure, therefore do not require maintenance;</li> <li>- the Agrément holder can provide a technical consulting service for calculations and installation advice.</li> </ul> <p><b>9 Durability</b></p> <ul style="list-style-type: none"> <li>- once installed the EPS beads are protected in service from agents liable to cause deterioration and will be effective as insulation for the life of the building in which they are installed.</li> </ul>	
<p><b>Version</b> 01</p>	<p><b>Expert Centre Building Envelope</b> Copyright© 2017 Kiwa BDA</p>	<p>Page 4 of 9 pages</p>

**8 Typical drill patterns**

The recommended drilling pattern is given in writing and as diagrams in the System Manual<sup>15</sup>. This is done for several situations which can be met in practice. For convenience of the reader the diagrams are given below.

Diagram 1: Full Fill Drill Pattern

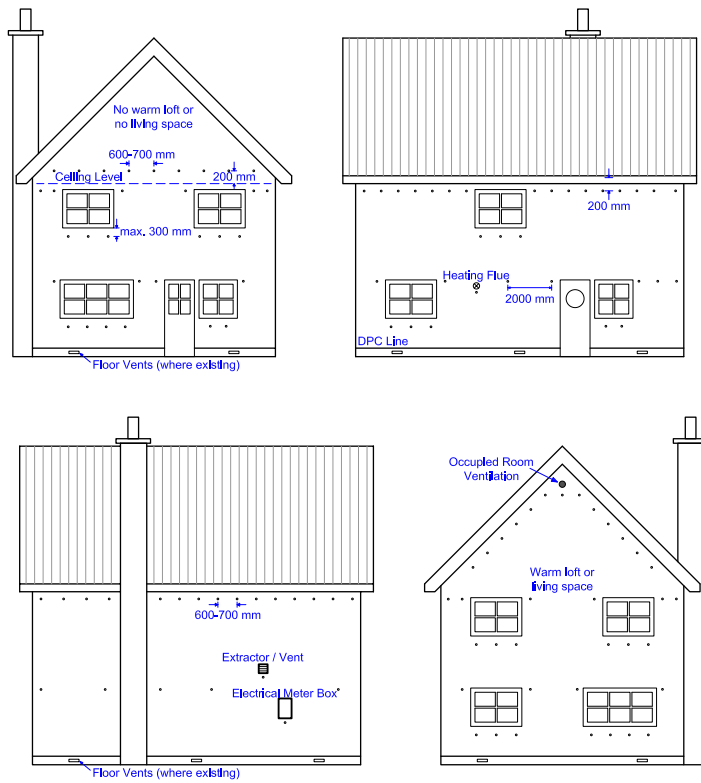
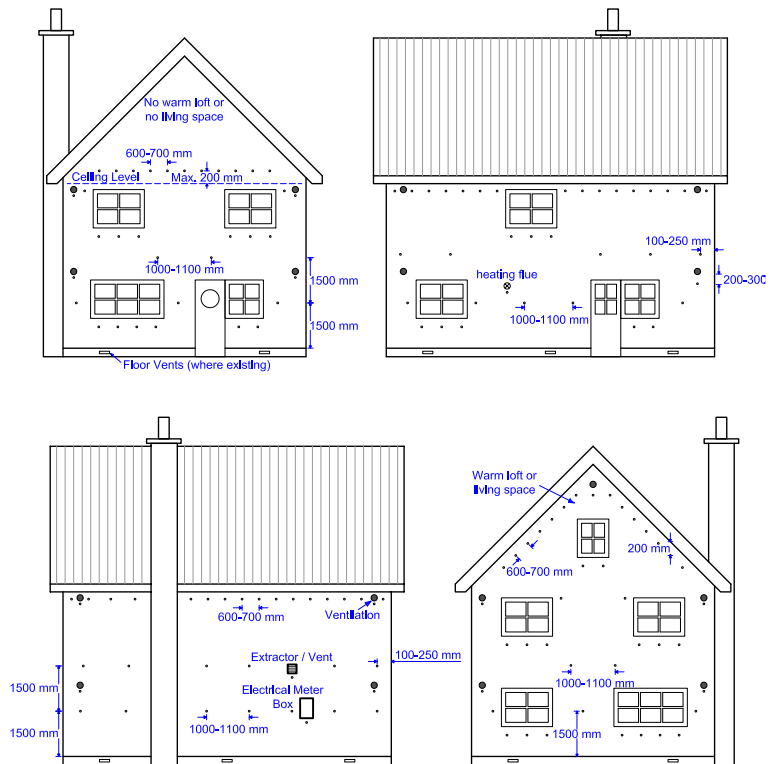

Diagram 2: Partial Fill Drill Pattern



Additional holes should be drilled at 1000mm and 1100mm apart at 1.5m

**8 Typical drill patterns**

Diagram 3: Thermal lance

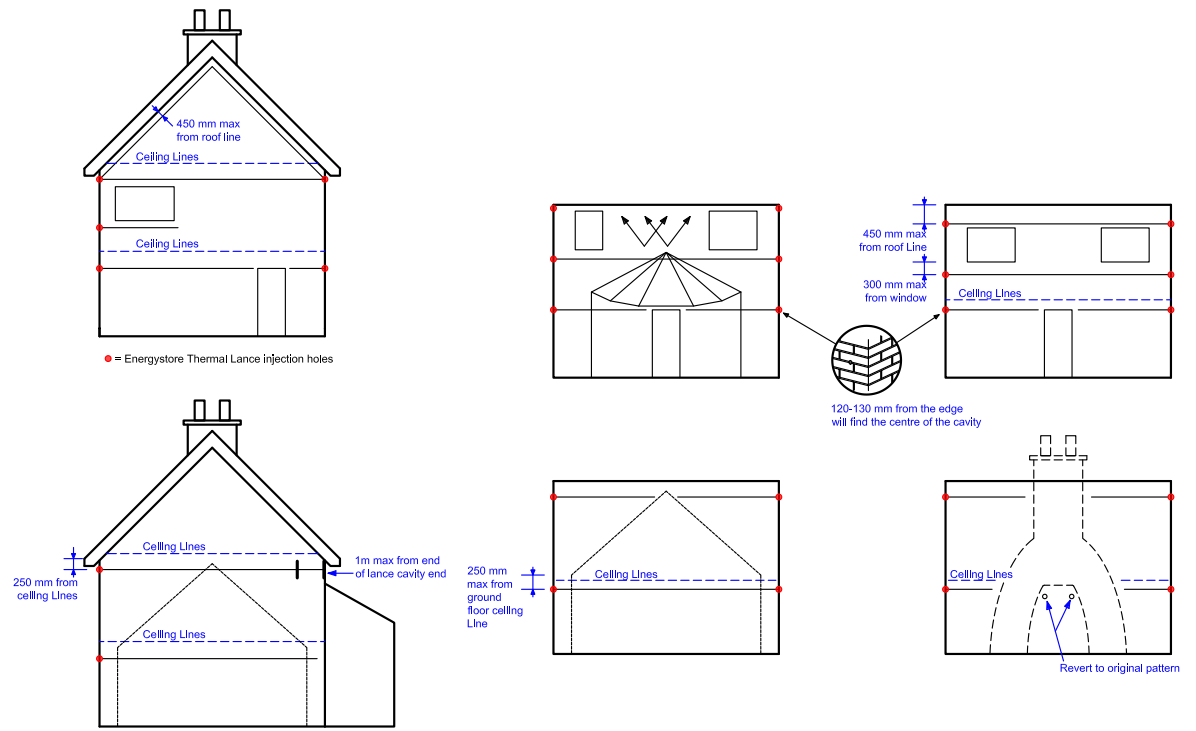
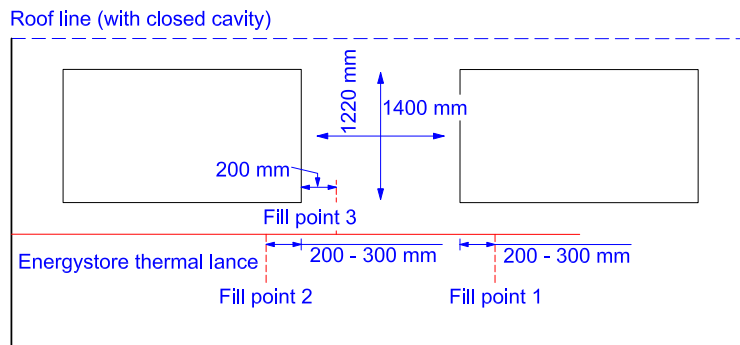

Diagram 4: Thermal lance between windows



<p><b>9 Installation procedure</b></p>	<p><b>1 General</b></p> <ul style="list-style-type: none"> <li>- details of the materials of the System are given in section 3 of this Agrément;</li> <li>- installation of CWI and ancillary items shall be in accordance with the Agrément holder's requirements<sup>15</sup> and current good building practice; installations shall be done by operatives trained and approved by the Agrément holder;</li> <li>- prior to installation the procedure includes a pre-site inventory, on-site checks (internal and external) and being aware of omitted areas; these topics are described in the System Manual<sup>15</sup>.</li> </ul> <p><b>Omitted areas</b></p> <p>In some circumstances, access for drilling injection holes and filling with insulation may be limited by features such as carports, conservatories, cladding or tiling. The practicability of safely accessing and making good these areas, or installing the insulation through the inner leaf, may outweigh the benefits of insulating these areas.</p> <p><b>2 Delivery and site handling<sup>15</sup></b></p> <ul style="list-style-type: none"> <li>- the EPS beads are packed in polythene sacks or bulk containers. The packaging is otherwise unprotected. Therefore, care shall be taken during transit and storage to avoid damage. The EPS beads have an indefinite storage life, but should be kept dry;</li> <li>- the bonding agent (adhesive) is delivered in plastic drums/containers; it is ready to use for at any temperature; there is a 'winter mix' adhesive available which has a flow additive to assist in cold temperatures. However, this is not compulsory in cold weather. The containers should be stored at a temperature between 5 °C and 25 °C, kept frost-free and away from direct sunlight as described on page 4 of the System Manual;</li> <li>- the packaging of beads and adhesive is marked with the Kiwa BDA ECBE logo including the number of this Agrément.</li> </ul> <p><b>3 Operation on site<sup>15</sup></b></p> <p><b>3.1 Safety precautions</b></p> <ul style="list-style-type: none"> <li>- to carry out work at heights above that reached from ground level, access may be by ladder, scaffold, suspended platform or hydraulic platform; hence personal protective equipment (PPE) shall be used e.g. a safety harness and/or ladder support;</li> <li>- put pipes and cables from the vehicle close together and use appropriate safety signs or ramps;</li> <li>- if possible plug electrical equipment in using an RCD to prevent shortage to property and, in wet weather, electrical equipment shall always be protected.</li> </ul> <p><b>3.2 Internal pre-installation checks</b></p> <ul style="list-style-type: none"> <li>- there are 5 specific checks. Use a ladder, torch or borescope if necessary;</li> <li>- all openings in the inner or outer leaf of walls shall be checked to ensure that they are correctly sealed, with particular attention being given to electricity and gas meter boxes; any defects found should be dealt with using the appropriate material;</li> <li>- rising damp will have to be reported and a decision about remedial action has to be made BEFORE any installation can proceed.</li> </ul> <p><b>3.3 External pre-installation checks</b></p> <ul style="list-style-type: none"> <li>- there are 6 specific checks. Use a ladder, torch or borescope if necessary;</li> <li>- the most important check is suitability for installation of CWI. NOT suitable are properties with e.g. replacement wall ties, timber framed or metal framed walls, excessive damp and excessive external cracks;</li> <li>- check for essential and non-essential vents, chimneys/flues and combustion air ventilators; for these take note of CIGA Technician's guide<sup>13</sup> to best practice;</li> <li>- check adjoining properties for any problems that may affect the correct installation of the required cavity barrier brushes. These must be fitted before any injection of material.</li> </ul> <p><b>4 Filling procedure</b></p> <ul style="list-style-type: none"> <li>- all necessary preparatory works, e.g. sleeving of vents, cavity brushes, etc., must be carried out prior to beginning of installation. See section 9.3 of this Agrément and all the (internal and external) checks as described in the System Manual<sup>15</sup> starting at page 12;</li> <li>- before injection check the bead flow rate and adhesive flow rate. The adhesive flow rate shall match the bead flow rate. These ratios are given in a Table of Flow Rates on page 6 in the System Manual<sup>15</sup>;</li> <li>- the injection procedure is described in detail on pages 14, 15 and 16 of the System Manual<sup>15</sup>. The sequence of filling and the sealing of holes are important for a good result.</li> </ul>	
<p><b>Version</b> 01</p>	<p><b>Expert Centre Building Envelope</b> Copyright© 2017 Kiwa BDA</p>	<p>Page 7 of 9 pages</p>

<p><b>10 Building Regulations</b></p>	<p><b>1 Requirements: The Building Regulations 2010 and subsequent amendments</b></p> <ul style="list-style-type: none"> <li>- B3(4) Internal fire spread (Structure) - walls filled with the EPS beads do not prejudice the spread of fire. The risk is limited further if the internal wall linings and the exterior of the external wall meet all provisions of Parts B2 and B4 of Approved Document B, volume 1;</li> <li>- C2(a) Resistance to moisture - the System does not absorb water by capillary action and may therefore be used in situations where it bridges the damp proof course (DPC) of the inner and outer leaf. See section 3 of this Agrément;</li> <li>- C2(b) Resistance to moisture - a wall incorporating the product can resist rain penetration and satisfy this Requirement. See section 3 of this Agrément and Approved Document C;</li> <li>- C2(c) Resistance to moisture - the System can contribute to satisfying this Requirement. See section 7.6 of this Agrément;</li> <li>- L1(a)(i) Conservation of fuel and power - the System can contribute to meeting this Requirement. See sections 7.4 and 7.5 of this Agrément;</li> <li>- Regulation 7 Materials and workmanship - the CWI is manufactured from suitably safe and durable materials for their application and can be installed to give a satisfactory performance. See section 9 of this Agrément;</li> <li>- Regulation 26 - (O) - CO<sub>2</sub> emission rates for new buildings and <ul style="list-style-type: none"> <li>- (A) - Fabric energy efficiency rates for new dwellings</li> <li>- the System will contribute to satisfying these Regulations; see sections 7.4, 7.5 and 7.7 of this Agrément.</li> </ul> </li> </ul> <p><b>2 Requirements: The Building (Amendment) Regulations 2014 (Wales) and subsequent amendments</b></p> <ul style="list-style-type: none"> <li>- C2(a) Resistance to moisture - the CWI does not absorb water by capillary action and may therefore be used in situations where it bridges the damp proof course (DPC) of the inner and outer leaf. See section 3 of this Agrément;</li> <li>- C2(b) Resistance to moisture - a wall incorporating the CWI can resist rain penetration and satisfy this Requirement. See section 3 of this Agrément and Approved Document C;</li> <li>- C2(c) Resistance to moisture - the System can contribute to satisfying this Requirement. See section 7.6 of this Agrément;</li> <li>- L1(a)(i) Conservation of fuel and power - the System can contribute to meeting this Requirement. See sections 7.4 and 7.5 of this Agrément;</li> <li>- Regulation 7 Materials and workmanship - the CWI is manufactured from suitably safe and durable materials for their application and can be installed to give a satisfactory performance. See section 9 of this Agrément;</li> <li>- Regulation 26 - (O) - CO<sub>2</sub> emission rates for new buildings and <ul style="list-style-type: none"> <li>- (A) - Fabric energy efficiency rates for new dwellings</li> <li>- the System will contribute to satisfying these Regulations; see sections 7.4, 7.5 and 7.7 of this Agrément.</li> </ul> </li> </ul> <p><b>3 Requirements: The Building Regulations 2004 (Scotland) and subsequent amendments</b></p> <p><b>3.1 Regulations 8 (1)(2) Durability of materials and workmanship</b></p> <ul style="list-style-type: none"> <li>- the CWI is manufactured from acceptable materials and is considered to be adequately resistant to deterioration and wear under normal service conditions, provided they are installed in accordance with the requirements of this Agrément. See section 9 of this Agrément.</li> </ul> <p><b>3.2 Regulation 9 Building Standards - Construction</b></p> <ul style="list-style-type: none"> <li>- 2.6 Fire spread to neighbouring buildings - the material of the System is combustible but may be used in walls of buildings in accordance with the exceptions permitted in this standard with reference to the clauses 2.6.5 (Domestic) and 2.6.6 (Non-Domestic) of the Technical Handbooks;</li> <li>- 3.4 Moisture from the ground - the System can contribute to a construction satisfying this standard with reference to clause 3.4.1 of the Technical Handbooks; the System can be used in situations where it bridges the DPC of the inner and outer leaf. See section 3 of this Agrément;</li> <li>- 3.10 Precipitation - the System will contribute to satisfying this standard with reference to clause 3.10.1 of the Technical Handbook (Domestic) provided it complies with the conditions set out in sections 1.2 and 3 of this Agrément;</li> <li>- 3.15 Condensation - the material of the System will contribute to limiting the risk of surface and interstitial condensation; see section 7.6 of this Agrément;</li> <li>- 6.1(b) Carbon dioxide emissions;</li> <li>- 6.2 Building insulation envelope - the System will contribute to satisfying the requirements of these Standards; see sections 7.4, 7.5 and 7.7 of this Agrément;</li> <li>- 7.1(a)(b) Statement of sustainability - the material of the System can contribute to satisfying the relevant Requirements of Regulation 9, Standards 1 to 6, and therefore will contribute to a construction meeting a bronze level of sustainability as defined in this Standard; in addition, the System can contribute to a construction meeting a higher level of sustainability as defined in this Standard; see sections 7.4, 7.5 and 7.7 of this Agrément.</li> </ul>	
<p><b>Version</b> 01</p>	<p><b>Expert Centre Building Envelope</b> Copyright © 2017 Kiwa BDA</p>	<p>Page 8 of 9 pages</p>



